

Arbre

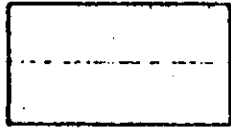

Epaulement

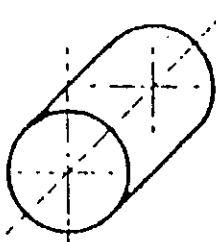
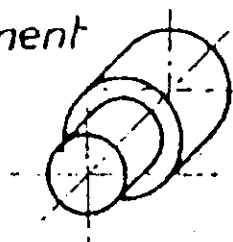

Gorge

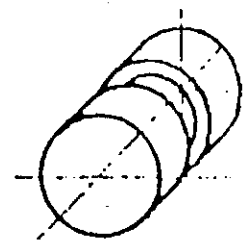

Alésage

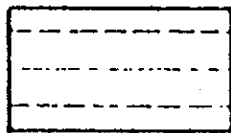
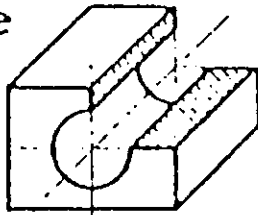

Epaulement intérieur

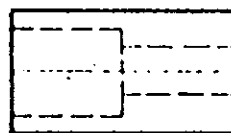
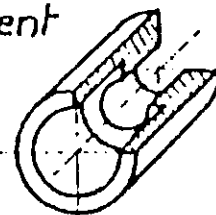

Gorge intérieure

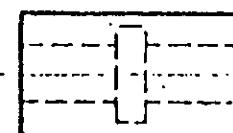
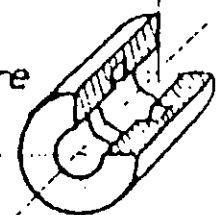

Collerette

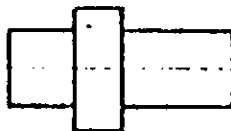
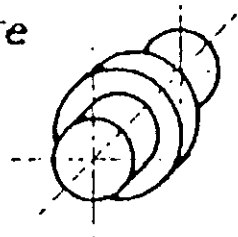

Dégagement

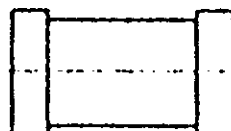
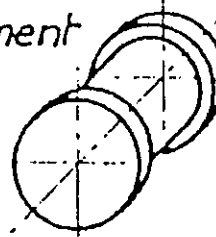

Chanfrein

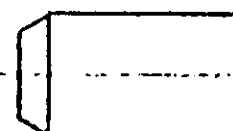
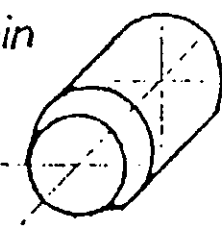

Lamage

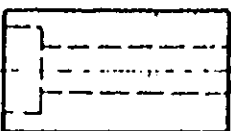
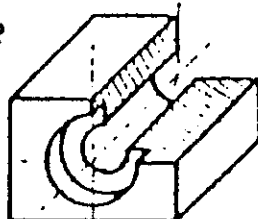

Chambrage

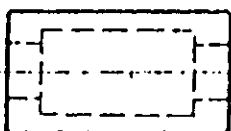
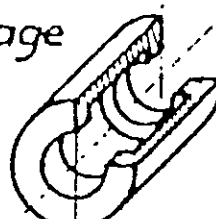

Méplat

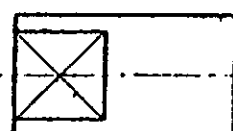
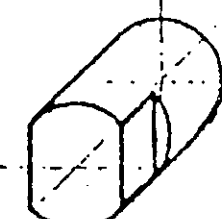

Rep.

Nb.

DESIGNATION

MATIERE

OBSERVATIONS

Lycée Professionnel de l'automobile - BRON .

Ech:

TERMINOLOGIE DES FORMES CYLINDRIQUES

NOM :

SECTION :

DATE :

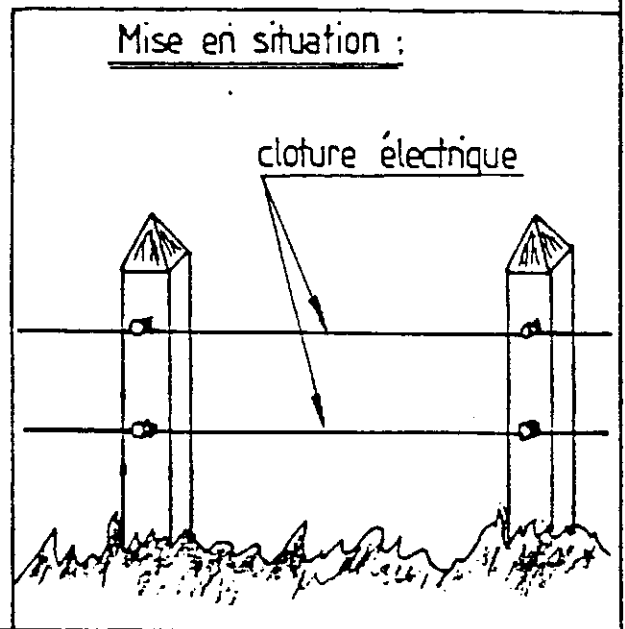
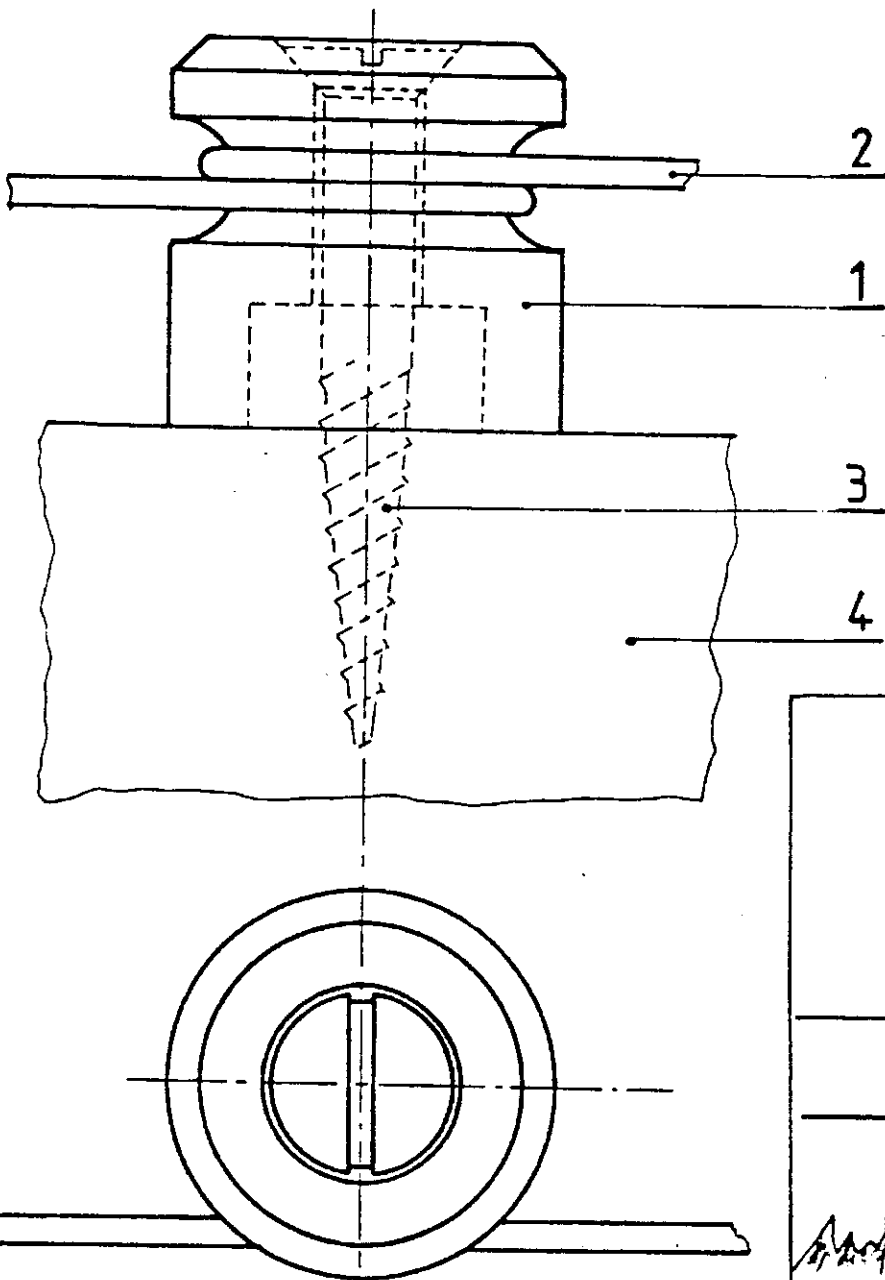

Travail demandé

sur A4 Vertical éch. 2:1 dessin de la pièce 1 seule

1^{er} Partie : - en vue de face
 - en vue de dessus
 - cartouche

2^{ème} Partie : * Application vue en coupe
 - Faire une vue de droite coupe A-A

4	1	POTEAU	Bois	
3	1	VIS A BOIS F/90 6-45		NF E 27-142
2	1	CONDUCTEUR		
1	1	ISOLATEUR	Bakélite	
Rp	Nb	Désignation	Matière	Obs.

Ech. 2:1



L.E.P

Nom: _____

Classe: _____

Date: _____

N° _____

ISOLATEUR DE CLOTURE ÉLECTRIQUE